

SANSUI 4000 SC

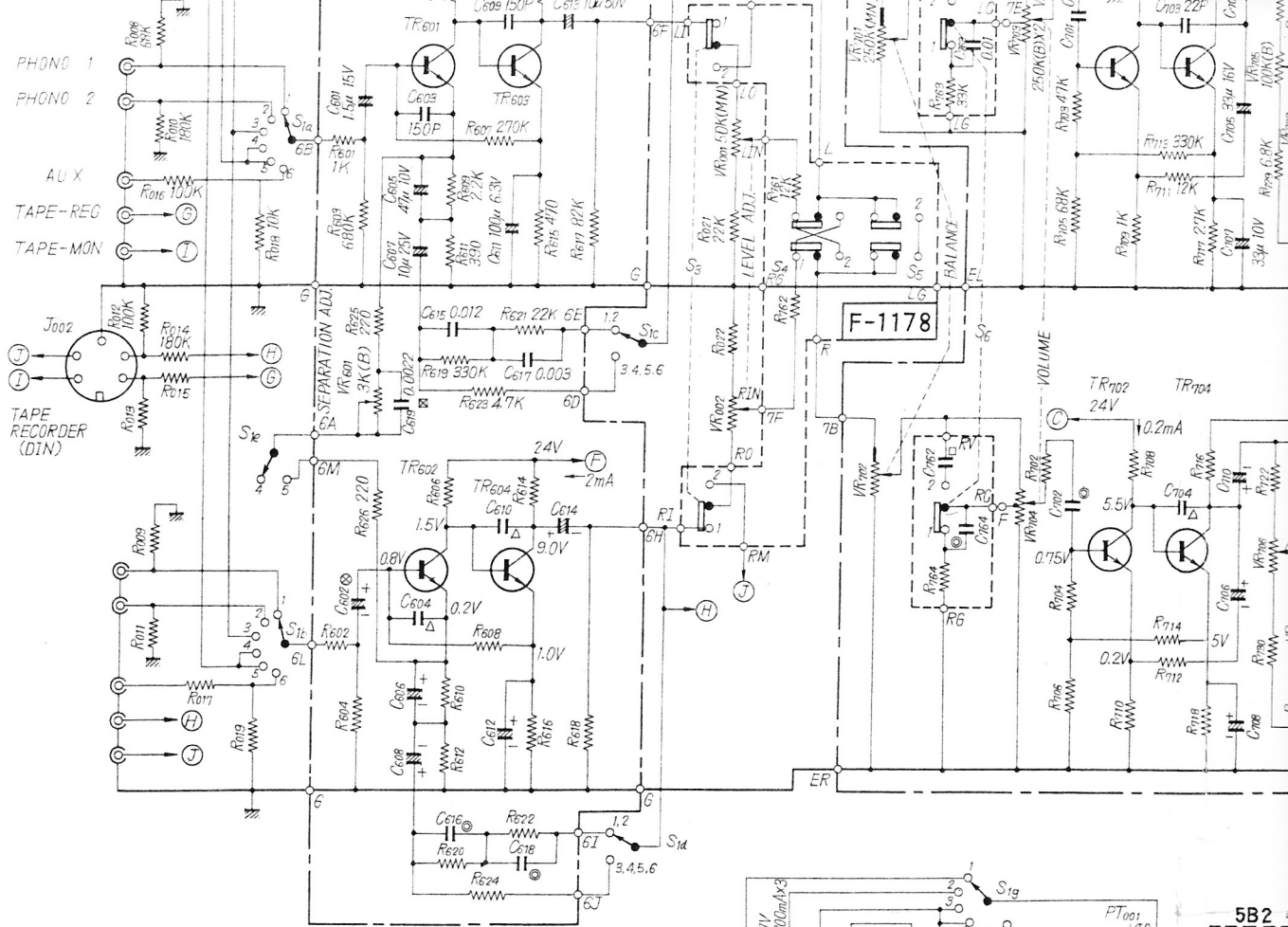

CONNECTION

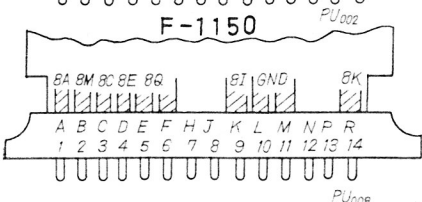
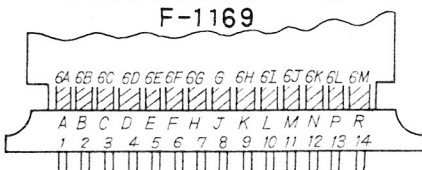
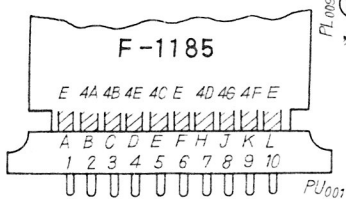

- CAPACITOR**
 △ CERAMIC
 ○ OIL
 ● MYLAR
 □ MICA
 ⊠ TANTALUM
 ⊞ STYROL
- ALL RESISTORS 1/4 WATT
 UNLESS OTHERWISE NOTE

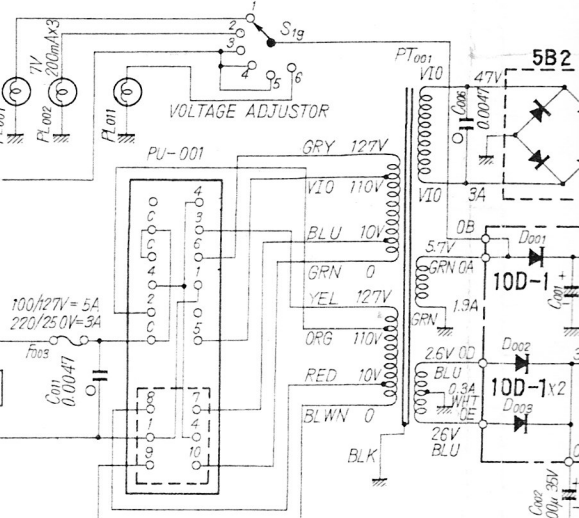
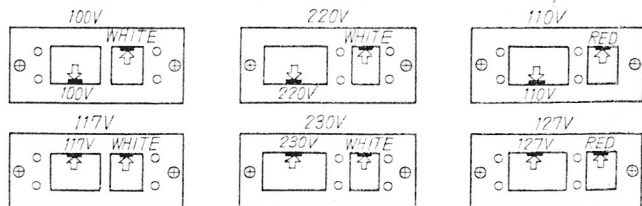

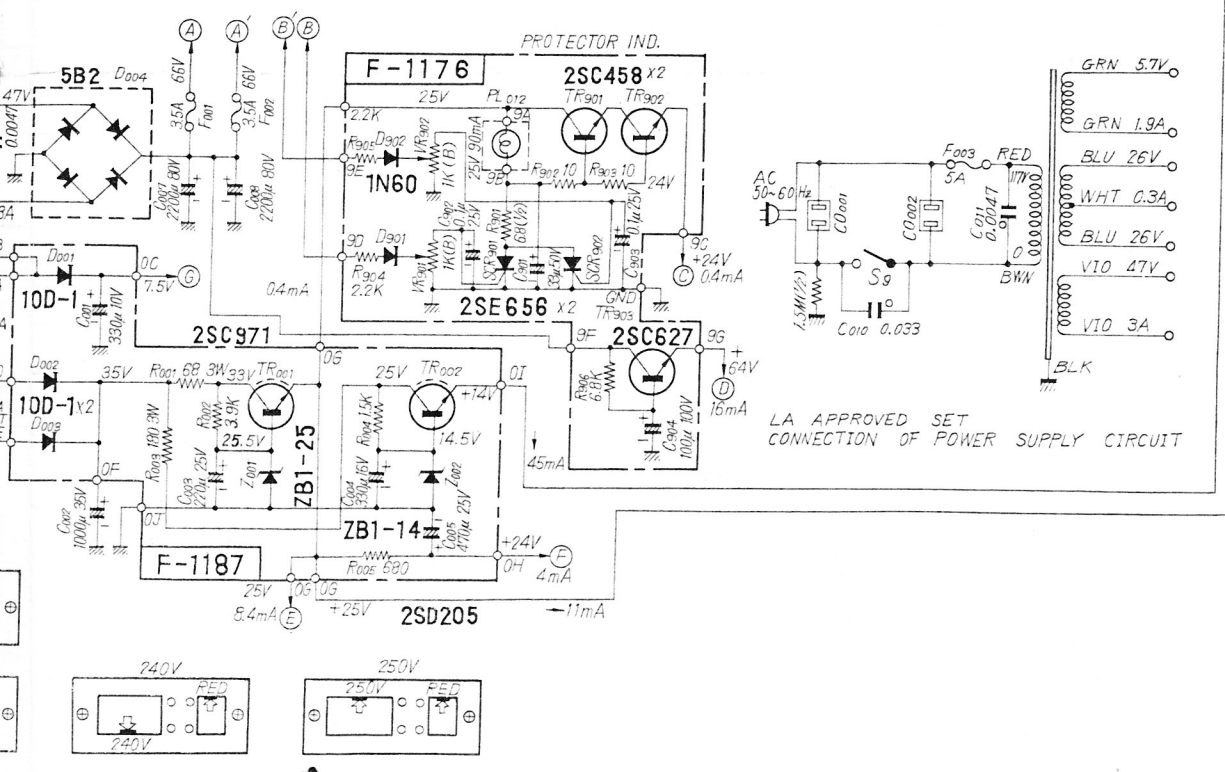
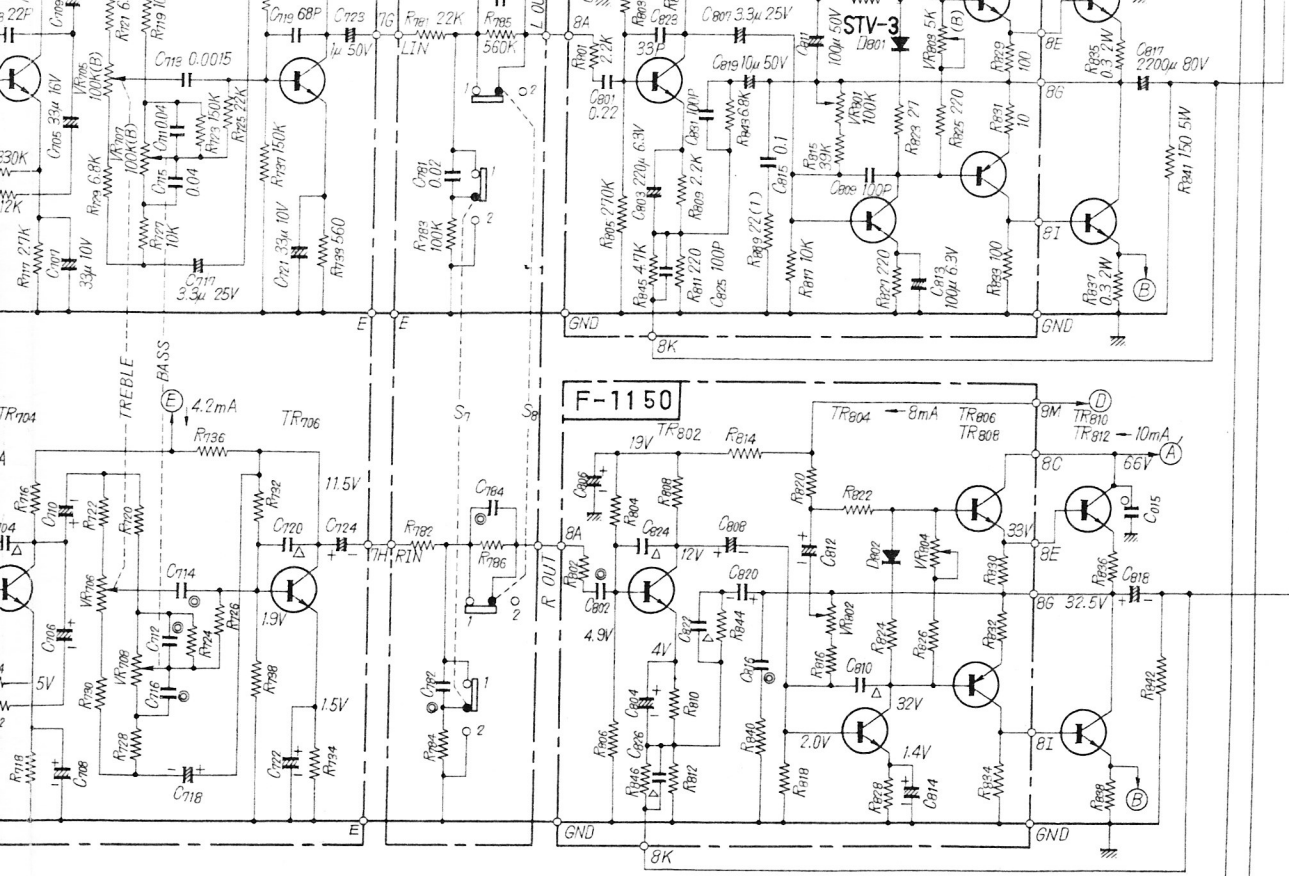

* All rights reserve specifications subject to change without notice.

SANSUI 4000 SCHEMATIC DIAGRAM

SELECTOR $S_1(a-j)$

1. PHONO 1
2. PHONO 2
3. AM
4. FM MONO
5. FM AUTO
6. AUX

S_{2a} SPEAKER (R)

S_{2b} SPEAKER (L)

S_3 TAPE MONITOR

1.OFF 2.ON

S_4 REVERSE

1.OFF 2.ON

S_5 MON

1.OFF 2.ON

S_6 LOUDNESS

1.OFF 2.ON

S_7 HIGH FILTER

1.OFF 2.ON

S_8 LOW FILTER

1.OFF 2.ON

S_9 POWER

S_{10} ANTENNA

1.DIST 2.LOC

S_{11} MUTING

1.OFF 2.ON

S_{12} MPX NOISE

CANCELER

1.OFF 2.ON

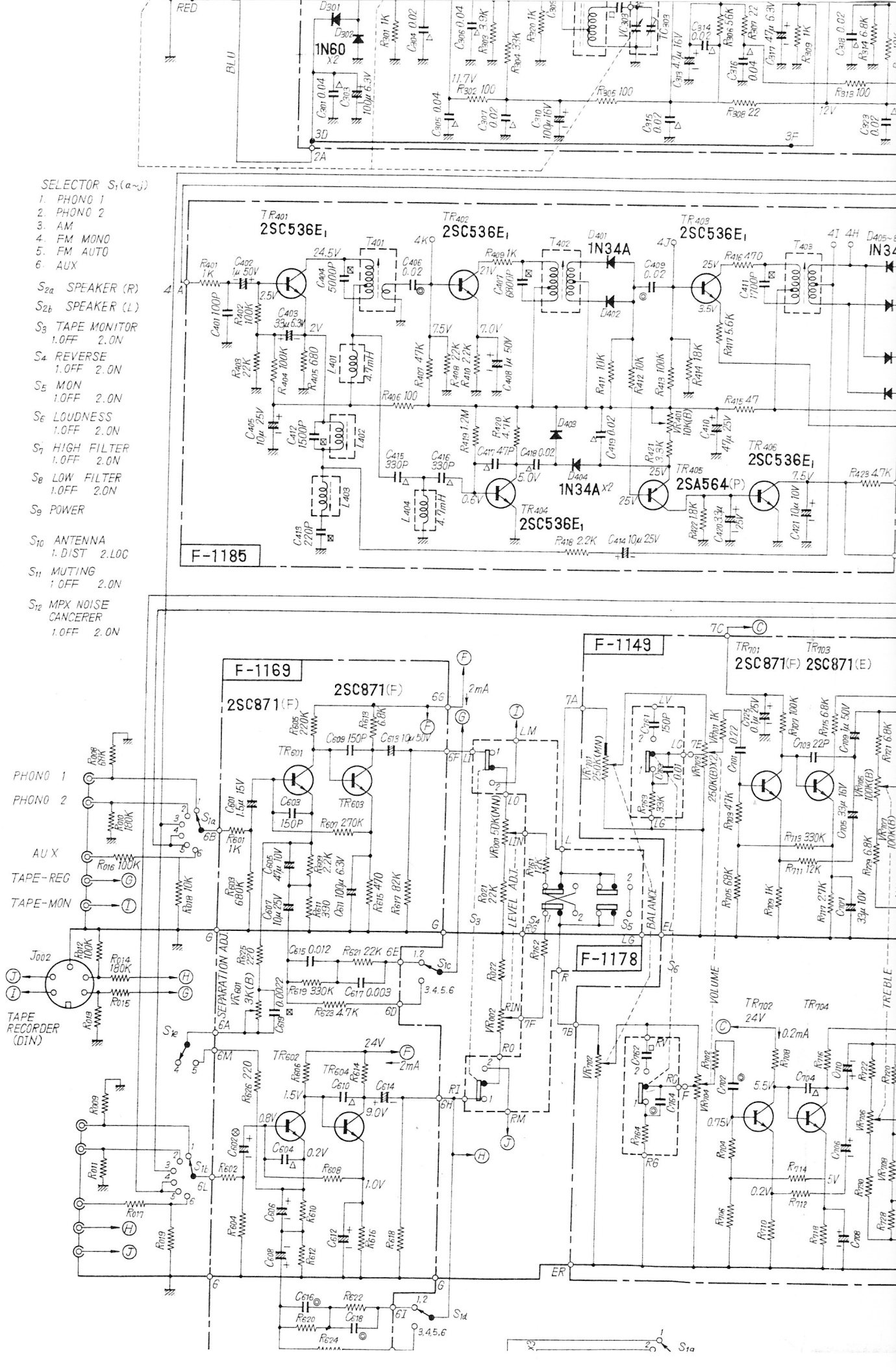

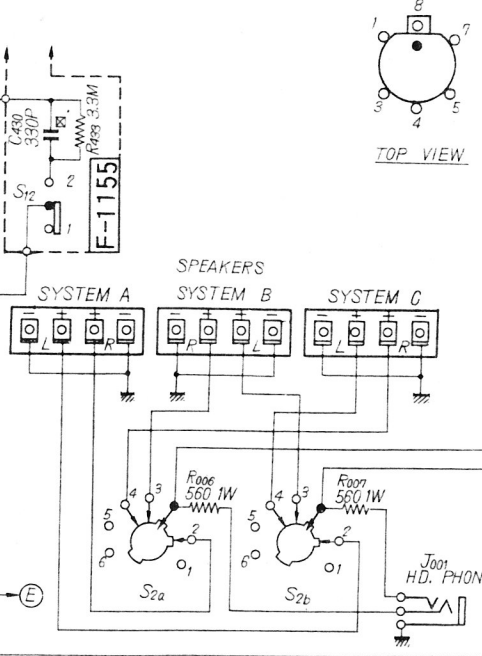
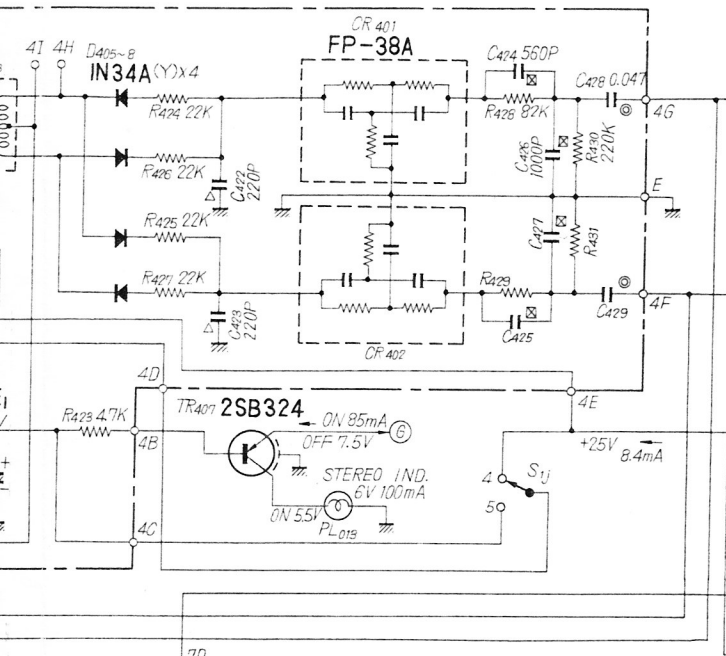
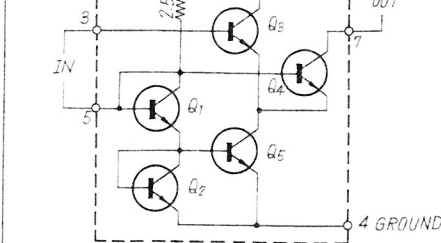
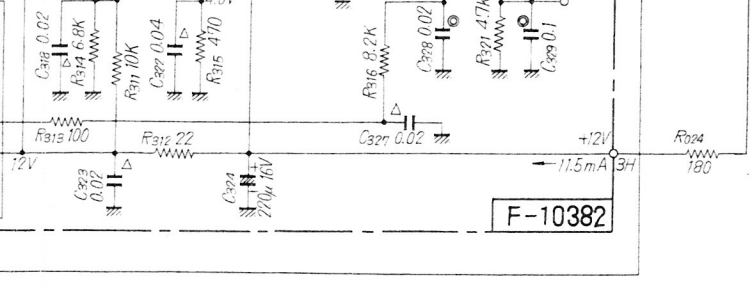

Schematic Diagram

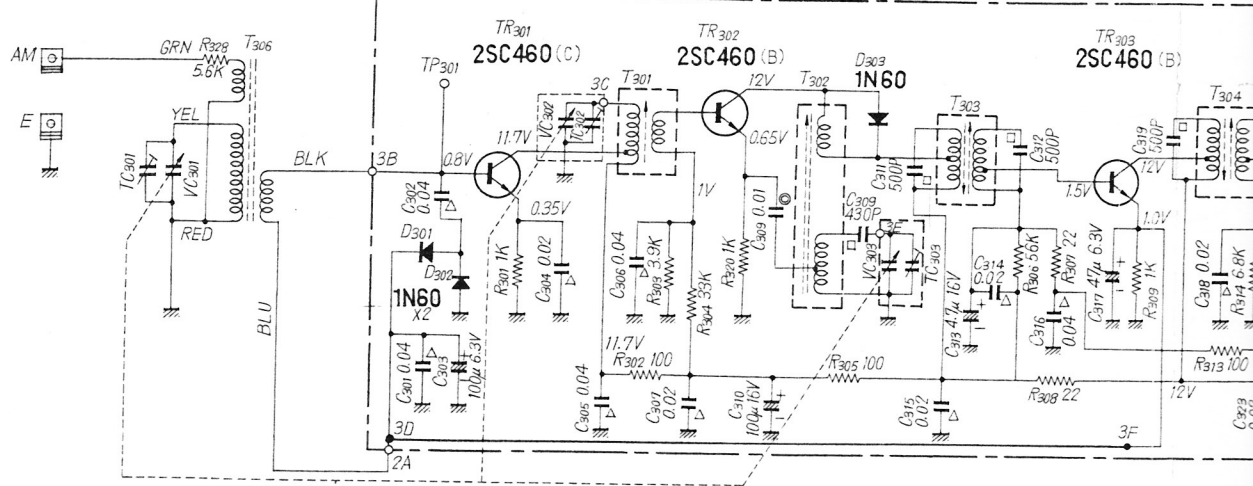
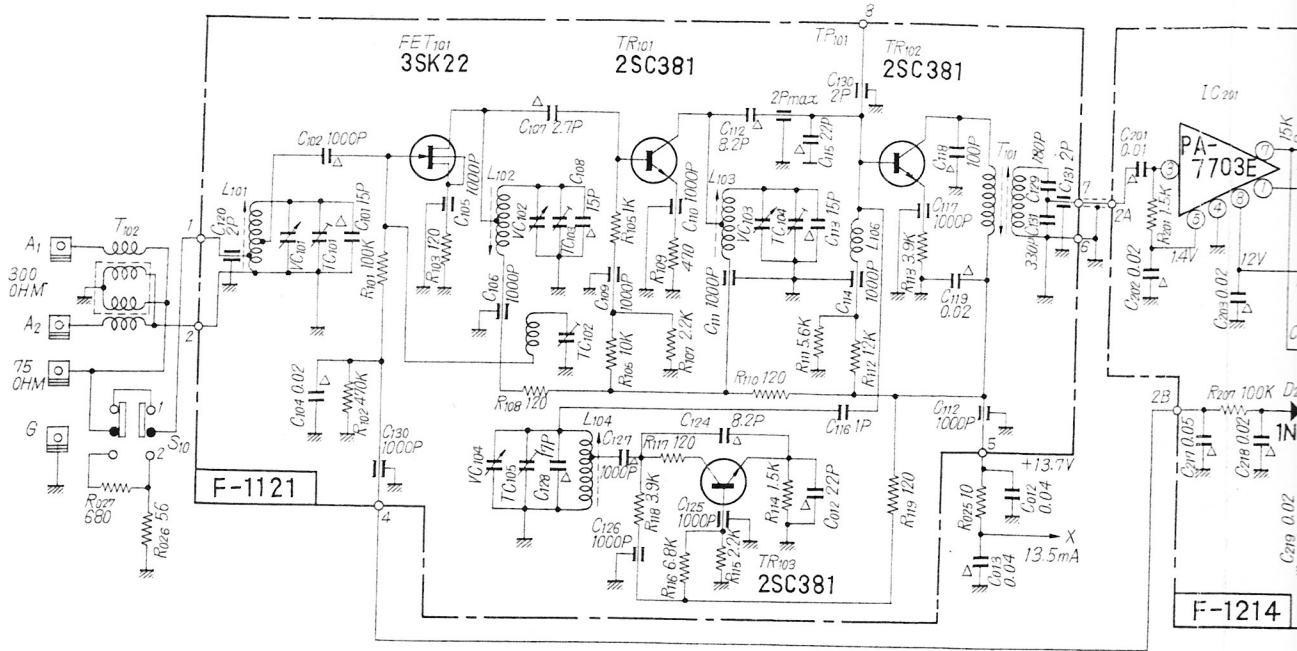

SELECTOR S₁(a-j)

1. PHONO 1
2. PHONO 2
3. AM
4. FM MONO
5. FM AUTO
6. AUX

- S_{2a} SPEAKER (R)
 S_{2b} SPEAKER (L)
 S₃ TAPE MONITOR
 1.OFF 2.ON
 S₄ REVERSE
 1.OFF 2.ON
 S₅ MON
 1.OFF 2.ON
 S₆ LOUDNESS
 1.OFF 2.ON
 S₇ HIGH FILTER
 1.OFF 2.ON
 S₈ LOW FILTER
 1.OFF 2.ON
 S₉ POWER
 S₁₀ ANTENNA

